

Anleitung. Instructions. Mode d'emploi.

FEUERLÖSCHTEICH H0 1079

de Vor Gebrauch die Sicherheitshinweise und Anleitung genau lesen und beachten.

Vor dem Zusammenbau sollten Sie sich mit den Einzelteilen vertraut machen, diese sorgfältig abtrennen und ggf. z.B. mit feinem Schmirgelpapier entgraten. Vor der Montage die Teile gemäß der Anleitung vorsortieren. Zum Verkleben (wenig Klebstoff verwenden) empfehlen wir Alleskleber (z.B. UHU® kraft), Kunststoffkleber und Haftkleber. Dieser Bausatz wurde sorgfältig gepackt. Sollte trotzdem ein Teil fehlen, können Sie es unter Angabe der Teilenummer (siehe Abbildung unten) und Artikel-

nummer dieses Bausatzes direkt bei Busch anfordern.
en Read and follow these safety precautions and instructions carefully before use.

fr Avant d'utiliser ce produit, veuillez lire et suivre attentivement les consignes de sécurité et le mode d'emploi.

it Prima dell'uso leggere attentamente le istruzioni per l'uso e le avvertenze di sicurezza.

es Antes de montar leer las instrucciones de seguridad e indicaciones de montaje.

nl Voor gebruik de veiligheidsaanschuivingen en instructies goed lezen en opvolgen.

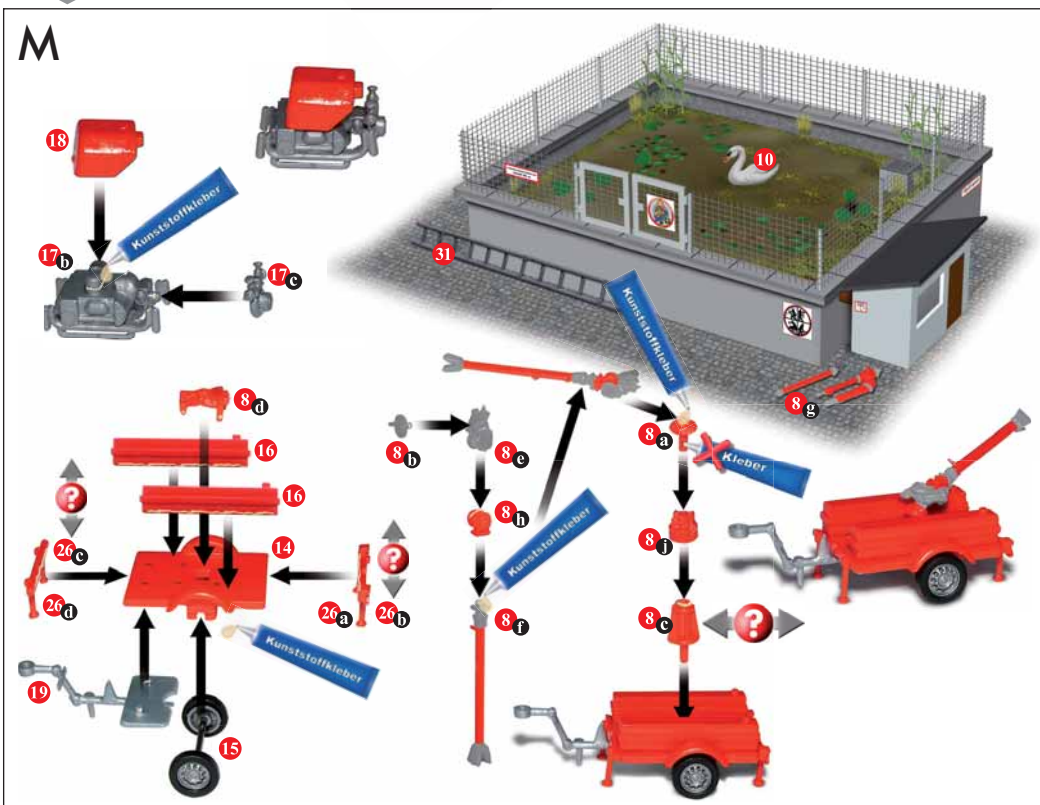
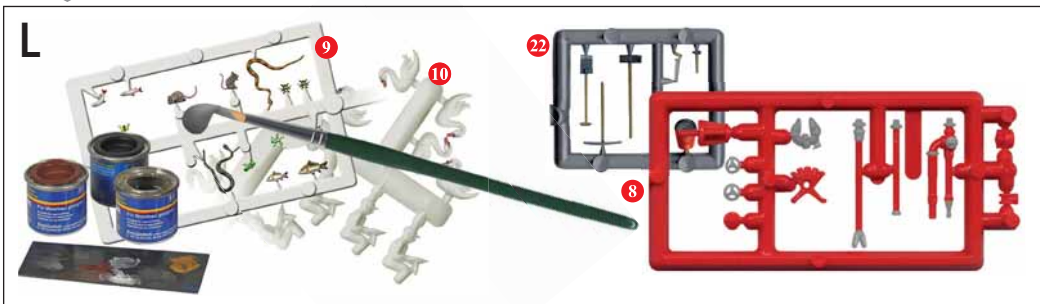
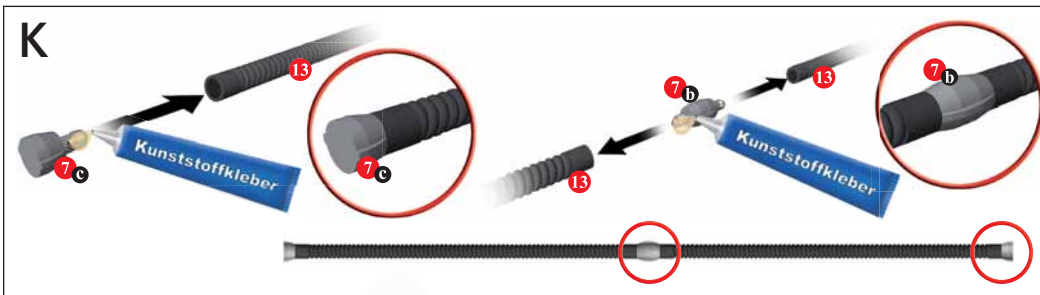

Inhalt (Stückliste). Parts list. Liste détaillée. Contenido. Inhoud.

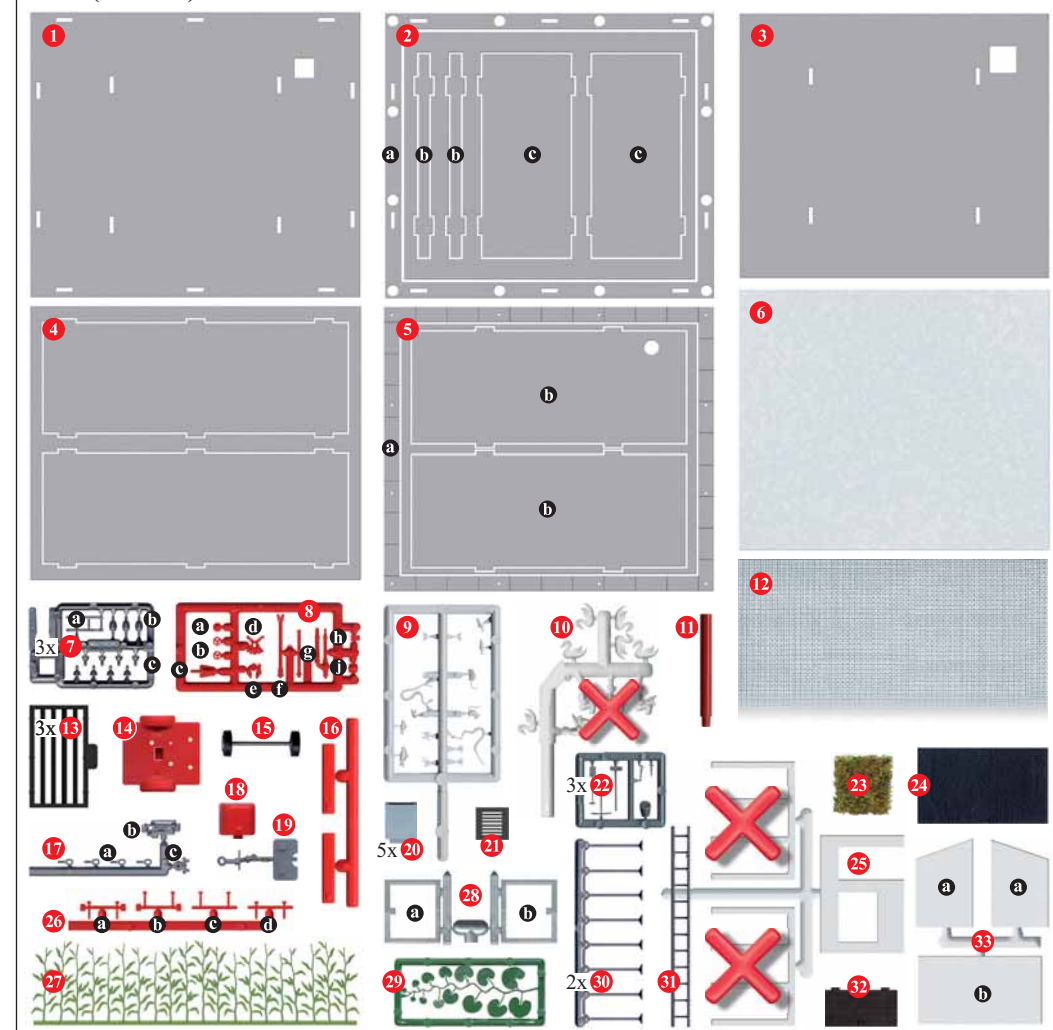

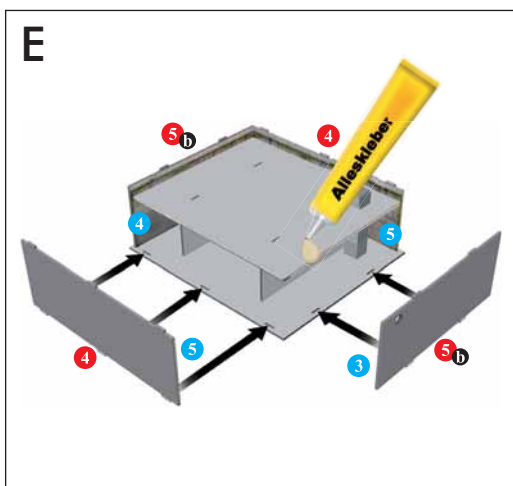
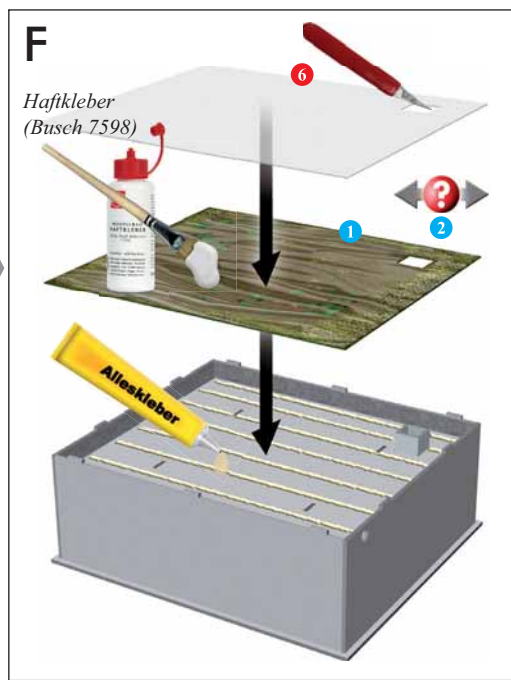
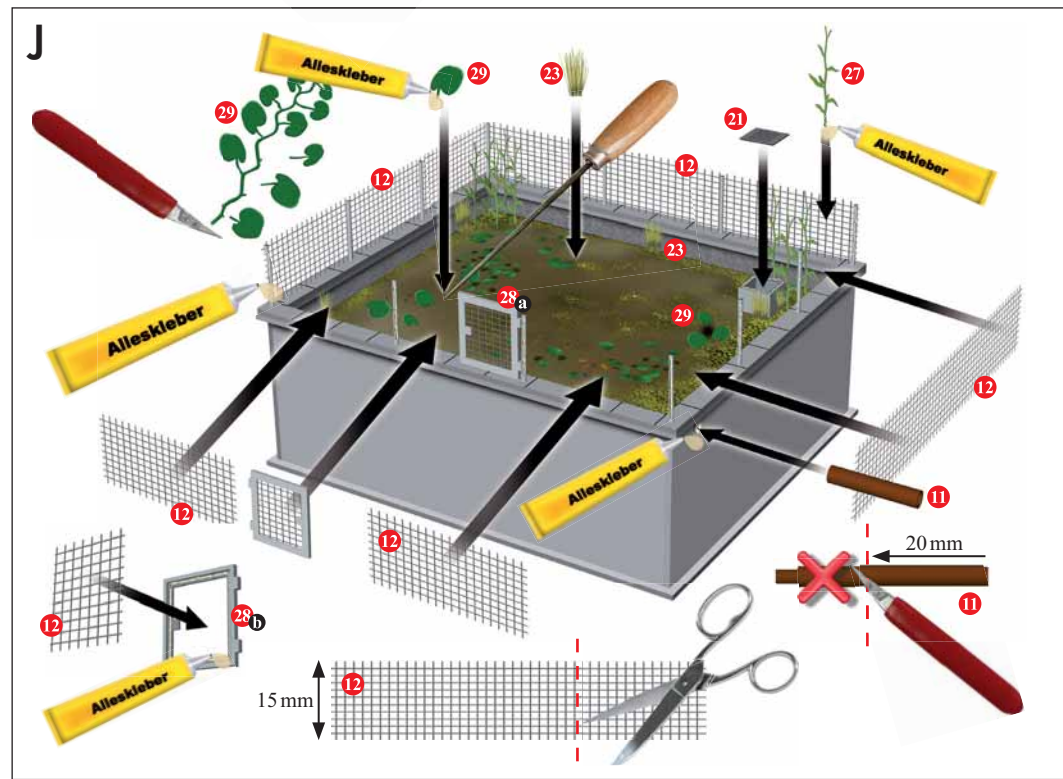
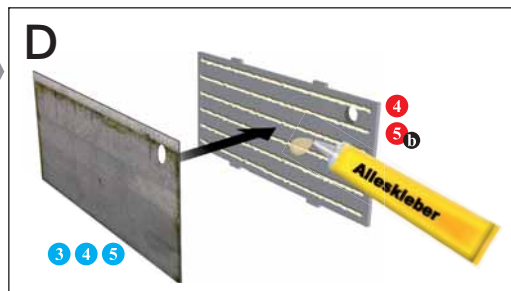
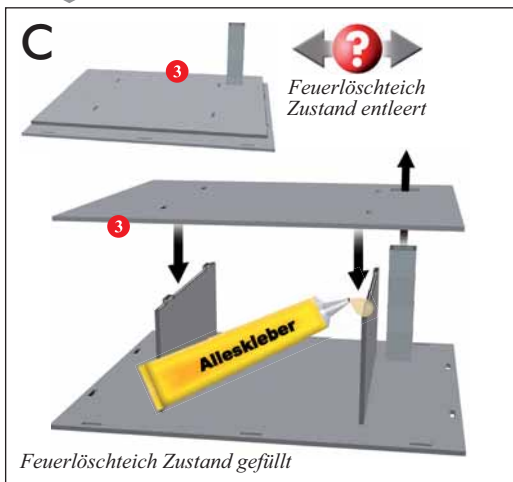
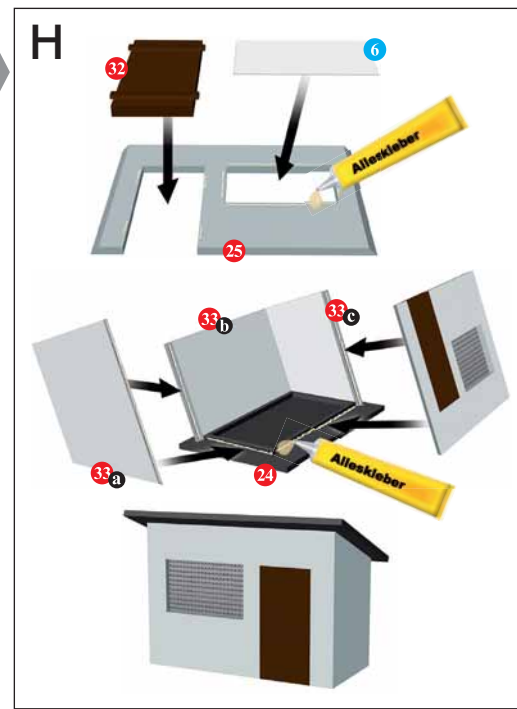
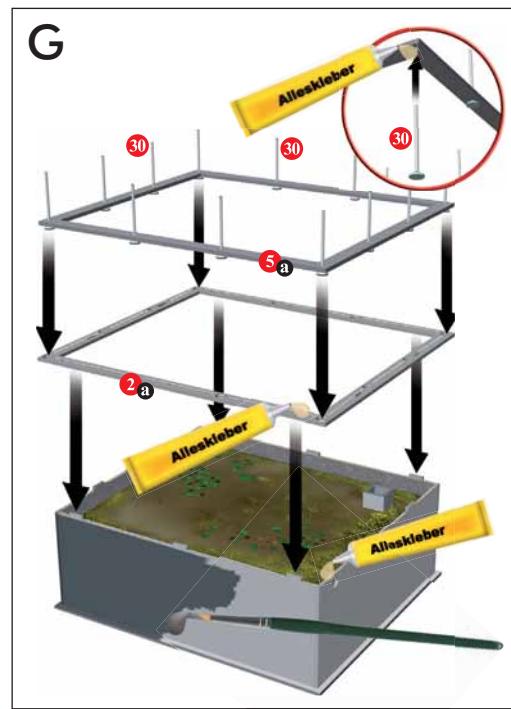
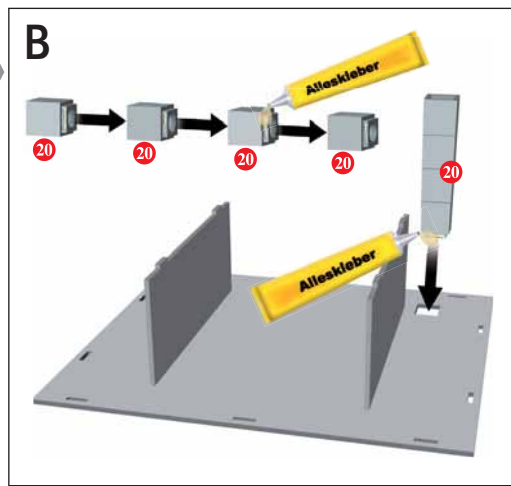
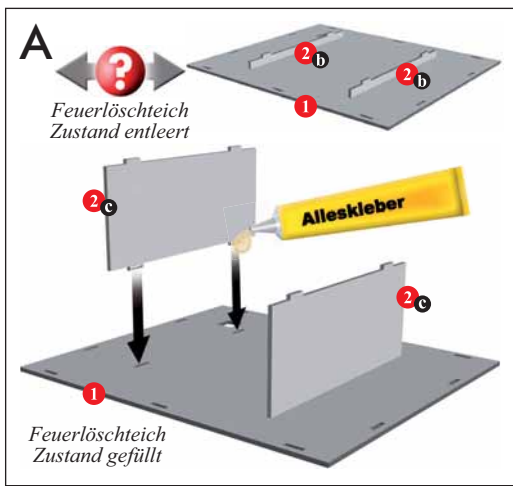

Ausschneidebogen

FEUERLÖSCHTEICH H0 1 0 7 9

1 Becken voll



3



6

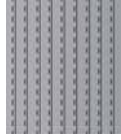

2 Becken leer



5

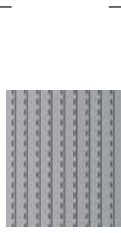

4



6

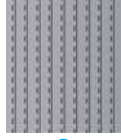

5

